

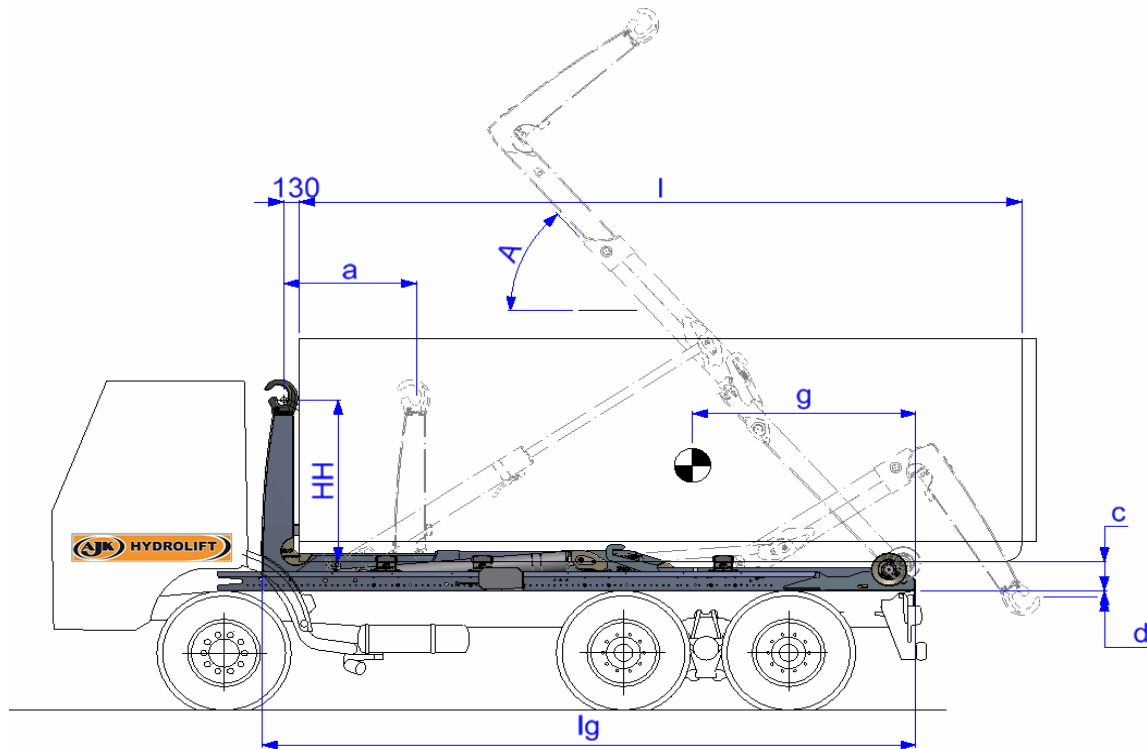

HL14_{sn}



Length	Stroke	Angle	Height	Depth	Bin Length	Point of gravity	Weight
lg	a	A	c	d	l	g	kg

4480	900	54	230	135	3300-5000	2390	1750
4680	900	52	230	135	3500-5250	2495	1795
4930	1025	50	230	135	3600-5500	2580	1810
5180	1100	53	230	225	3800-5750	2770	1880
5430	1100	49	230	225	4000-6000	2925	1900
5760	1300	54	230	220	4250-6250	3030	1970
5930	1300	52	230	220	4500-6500	3140	2000
6180	1400	55	230	200	4750-6750	3325	2080
6430	1400	52	230	200	5000-7000	3495	2110

Total exterior bin length is $l+250$ mm ($130+120$), the total rear over to end hookarm become 1000 mm
 Front side hook arm to center hook is 180 mm
 Distance rear side until tipping shaft is 100 mm, tipping shaft until roller center is 120 mm
 Vehicle chassis height is about 1100mm.

The constructor has the right to make modifications without prior notice

13/02/2013



Industriegebied Kanaal Noord 1 173, B-3960 Bree Tel : +32-89-46 93 90

e-mail : info@ajkhydrolift.eu