

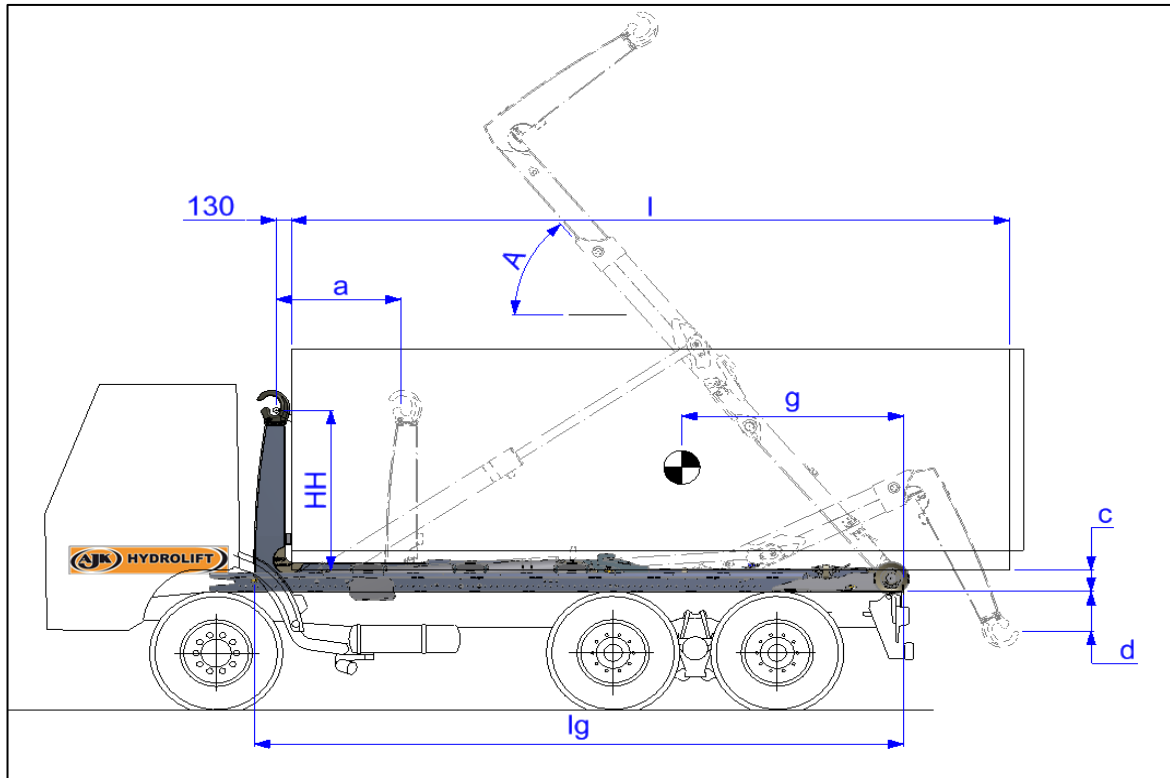

HLF20_{sn}



Length	Stroke	Angle	Height	Depth	Bin Length	Point of gravity	Weight
lg	a	A	c	d	l	g	kg

5180	1100	54	190	320	3750-5750	2860	2385
5430	1100	50	190	320	4000-6000	2985	2430
5760	1300	55	190	235	4250-6250	3075	2545
5930	1300	53	190	235	4500-6500	3185	2555

Total exterior bin length is $l+250$ mm ($130+120$), the total rear over to end hookarm become 1030 mm
 Front side hook arm to center hook is 180 mm
 Distance rear side until tipping shaft (=roller center) is 100 mm
 Vehicle chassis height is about 1100mm.

The constructor has the right to make modifications without prior notice

13/02/2013



Industriegebied Kanaal Noord 1 173, B-3960 Bree Tel : +32-89-46 93 90

e-mail : info@ajkhydrolift.eu